

MACHINE TOOL CONTROL TRANSFORMERS

FEATURES:

Core: High quality, high permeability silicon steel laminations. All-welded construction for a rugged one piece construction.

Coils: Computer designed coils are accurately wound, with optimum mean turns, for enhanced voltage regulation. Primary coils are fully interleaved. Copper magnet wire with insulation film complements modern winding techniques. Mylar®, Nomex® and other insulating papers are used to insulate layer to layer turns and primary to secondary windings.

Molded Terminal Blocks: Both MH and MT series transformers have high impact resin molded terminal blocks for easy access to the terminals. Terminals are separated by barriers. Use #10-32 combination Slotted/Robertson head screws.

Insulation Systems: MH Series up to 350VA—class A, 55°C temp rise, 105°C temp class; 500 to 1000VA—class B, 80°C temp rise, 130°C temp class; 1500VA and larger—class F, 115°C temp rise, 185°C temp class. MT Series

up to 250VA—class A, 55°C temp rise, 105°C temp class; 350 to 1000VA—class B, 80°C temp rise, 130°C temp class.

Mounting: Transformers can be mounted to operate in any position. MH Series are "H" style mounting. MT Series offers heavy steel universal mounting plate.

Finish: Black

Standards: MT Series— UL listed 252L and CSA LR #3902 and LR38216. MH Series— UL listed 252L and CSA LR #3902 listed.

Warranty: Ten years

Vacuum Impregnation: Polyester varnish and oven cured to seal surface and eliminate moisture.

Nameplate: Includes rating info, wiring diagram and terminal location.

Voltage Links: Included and packaged separately.

Fuse Kits: Optional primary and secondary fuse kits available.

SERIES MT MACHINE TOOL CONTROL TRANSFORMERS

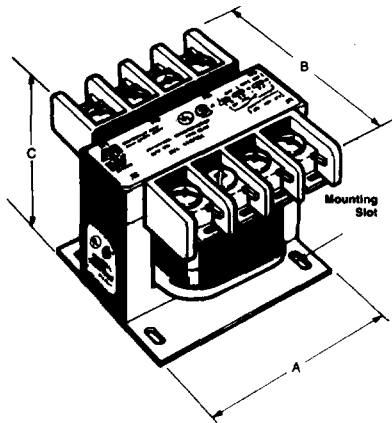

GROUP AA

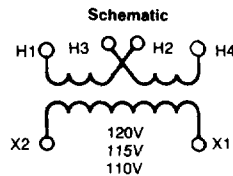
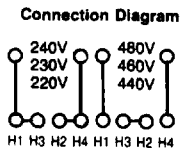

Primary Voltage: 240/480, 230/460, 220/440. **Secondary Voltage:** 120, 115, 110. 50/60 Hz. CSA and UL listed.

Mfr. No.	VA Rating	Output Amps	Overall Dimens. (In.)			Mtg. Slot* (In.)	Price Each
			A	B	C		
MT25MQMJ	25	0.22	3.00	3.00	2.75	A	\$ 19.08
MT50MQMJ	50	0.44	3.00	3.38	2.75	B	21.64
MT75MQMJ	75	0.65	3.00	3.88	2.75	C	25.79
MT100MQMJ	100	0.87	3.00	4.38	2.75	C	28.36
MT150MQMJ	150	1.30	4.50	4.00	3.75	B	31.36
MT200MQMJ	200	1.74	4.50	4.25	3.75	B	38.96
MT250MQMJ	250	2.17	4.50	4.63	3.75	B	45.40
MT350MQMJ	350	3.04	5.25	5.00	4.50	B	54.33
MT500MQMJ	500	4.35	5.25	5.88	4.50	B	67.05
MT750MQMJ	750	6.51	6.00	5.13	5.00	D	91.60
MT1000MQMJ	1000	8.70	6.00	6.00	5.00	D	112.71

GROUP BB

Schematic

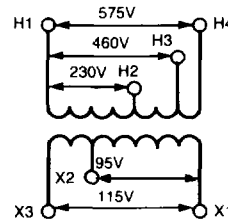

Primary Voltage: 230 460, 575. **Secondary Voltage:** 95/115, 95/115, 95/115. 50/60 Hz. CSA and UL listed.

Mfr. No.	VA Rating	Output Amps	Overall Dimens. (In.)			Mtg. Slot* (In.)	Price Each
			A	B	C		
MT25MBMH	25	0.22	3.00	3.25	2.75	A	\$ 36.13
MT50MBMH	50	0.44	3.00	3.63	2.75	B	38.25
MT75MBMH	75	0.65	3.00	4.13	2.75	C	40.72
MT100MBMH	100	0.87	3.00	4.75	2.75	C	41.16
MT150MBMH	150	1.30	3.75	4.25	3.75	B	49.56
MT200MBMH	200	1.74	4.50	4.38	3.75	B	57.33
MT250MBMH	250	2.17	4.50	4.88	3.75	B	66.87
MT350MBMH	350	3.04	5.25	5.25	4.50	B	80.30
MT500MBMH	500	4.35	5.25	6.25	4.50	B	84.98
MT750MBMH	750	6.51	6.00	5.50	5.00	D	116.34
MT1000MBMH	1000	8.70	6.00	6.50	5.00	D	151.85

GROUP CC

Connection Diagram

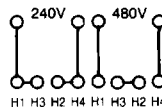

Schematic

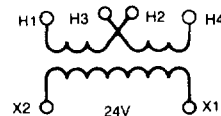

Primary Voltage: 240/480. **Secondary Voltage:** 24. 50/60 Hz. CSA and UL listed.

MT25QG	25	1.04	3.00	3.00	2.75	A	\$24.12
MT50QG	50	2.08	3.00	3.38	2.75	B	26.15
MT75QG	75	3.12	3.00	3.88	2.75	C	32.68
MT100QG	100	4.17	3.00	4.38	2.75	C	35.60
MT150QG	150	6.25	4.50	4.00	3.75	B	42.67
MT200QG	200	8.33	4.50	4.25	3.75	B	52.91
MT250QG	250	10.41	4.50	4.63	3.75	B	68.99



SERIES MT MACHINE TOOL CONTROL TRANSFORMERS

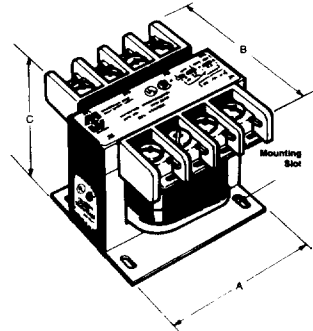

Up to 1000 VA

GROUP DD

Connection Diagram

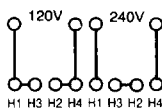

Schematic

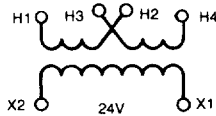

Primary Voltage: 120/240. Secondary Voltage: 24, 50/60 Hz. CSA and UL listed.

Mfr. No.	VA Rating	Output Amps	Overall Dimens. (In.)			Mtg. Slot (In.)	Price Each
			A	B	C		
MT25PG	25	1.04	3.00	3.00	2.75	A	\$24.12
MT50PG	50	2.08	3.00	3.38	2.75	B	26.32
MT75PG	75	3.12	3.00	3.88	2.75	C	32.86
MT100PG	100	4.17	3.00	4.38	2.75	C	35.69
MT150PG	150	6.25	4.50	4.00	3.75	B	42.93
MT200PG	200	8.33	4.50	4.25	3.75	B	52.91
MT250PG	250	10.41	4.50	4.63	3.75	B	69.43

GROUP EE

Schematic

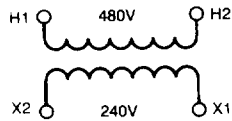

Primary Voltage: 480. Secondary Voltage: 240, 50/60 Hz. CSA and UL listed.

Mfr. No.	VA Rating	Output Amps	A	B	C	Mtg. Slot (In.)	Price Each
MT25CM	25	0.10	3.00	3.00	2.75	A	\$ 19.26
MT50CM	50	0.21	3.00	3.38	2.75	B	20.58
MT75CM	75	0.65	3.00	3.88	2.75	C	24.12
MT100CM	100	0.42	3.00	4.38	2.75	C	27.38
MT150CM	150	0.63	4.50	4.00	3.75	B	32.77
MT200CM	200	0.83	4.50	4.25	3.75	B	39.13
MT250CM	250	1.04	4.50	4.63	3.75	B	47.17
MT350CM	350	1.46	5.25	5.13	4.50	B	56.71
MT500CM	500	2.08	5.25	5.88	4.50	B	68.55
MT750CM	750	3.13	6.00	5.13	5.00	D	97.17
MT1000CM	1000	4.17	6.00	6.00	5.00	D	118.72

GROUP FF

Schematic

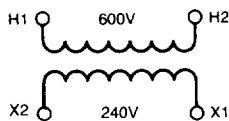

Primary Voltage: 600. Secondary Voltage: 240, 50/60 Hz. CSA and UL listed.

Mfr. No.	VA Rating	Output Amps	A	B	C	Mtg. Slot (In.)	Price Each
MT25AM	25	0.10	3.00	3.00	2.75	A	\$ 19.26
MT50AM	50	0.21	3.00	3.38	2.75	B	20.58
MT75AM	75	0.31	3.00	3.88	2.75	C	24.12
MT100AM	100	0.42	3.00	4.38	2.75	C	27.38
MT150AM	150	0.63	4.50	4.00	3.75	B	32.77
MT200AM	200	0.83	4.50	4.25	3.75	B	39.13
MT250AM	250	1.04	4.50	4.63	3.75	B	47.17
MT350AM	350	1.46	5.25	5.00	4.50	B	56.71
MT500AM	500	2.08	5.25	5.88	4.50	B	68.55
MT750AM	750	3.13	6.00	5.13	5.00	D	97.17
MT1000AM	1000	4.17	6.00	6.00	5.00	D	118.72

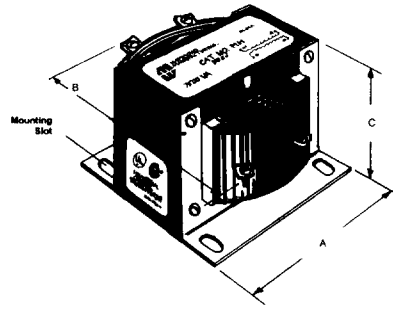

1500 to 7500 VA

GROUP GG

Schematic

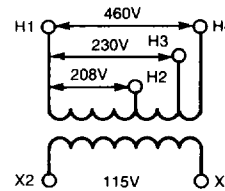

Primary Voltage: 208, 230, 460. Secondary Voltage: 115, 115, 115, 50/60 Hz. CSA and UL listed.

Mfr. No.	VA Rating	Output Amps	Overall Dimens. (In.)			Mtg. Slot (In.)	Price Each
			A	B	C		
MT25MLI	25	0.22	3.00	3.13	2.75	A	\$ 29.42
MT50MLI	50	0.44	3.00	3.63	2.75	B	33.92
MT75MLI	75	0.65	3.00	4.13	2.75	C	36.75
MT100MLI	100	0.87	3.00	4.63	2.75	C	38.43
MT150MLI	150	1.30	4.50	4.25	3.75	B	50.17
MT200MLI	200	1.74	4.50	4.38	3.75	B	61.13
MT250MLI	250	2.17	4.50	4.88	3.75	B	68.37
MT350MLI	350	3.04	5.25	5.13	4.50	B	84.45
MT500MLI	500	4.35	5.25	6.00	4.50	B	93.28
MT750MLI	750	6.51	6.00	5.25	5.00	D	129.50
MT1000MLI	1000	8.70	6.00	6.38	5.00	D	154.58

GROUP HH

Schematic

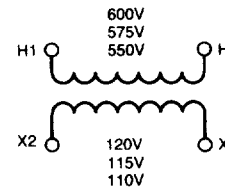

Primary Voltage: 600, 575, 550. Secondary Voltage: 120, 115, 110, 50/60 Hz. CSA and UL listed.

Mfr. No.	VA Rating	Output Amps	Overall Dimens. (In.)			Mtg. Slot (In.)	Price Each
			A	B	C		
MT25MAMJ	25	0.22	3.00	3.00	2.75	A	\$ 19.79
MT50MAMJ	50	0.44	3.00	3.38	2.75	B	21.91
MT75MAMJ	75	0.65	3.00	4.13	2.75	C	26.77
MT100MAMJ	100	0.87	3.00	4.38	2.75	C	28.97
MT150MAMJ	150	1.30	4.50	4.00	3.75	B	34.89
MT200MAMJ	200	1.74	4.50	4.25	3.75	B	43.20
MT250MAMJ	250	2.17	4.50	4.63	3.75	B	51.76
MT350MAMJ	350	3.04	5.25	5.00	4.50	B	67.58
MT500MAMJ	500	4.35	5.25	5.88	4.50	B	73.76
MT750MAMJ	750	6.51	6.00	5.13	5.00	D	103.53
MT1000MAMJ	1000	8.70	6.00	6.00	5.00	D	124.64

*Mtg. Slots: A = .22 x .44; B = .22 x .75; C = .22 x .50; D = .31 x 1.13.

SERIES MT MACHINE TOOL CONTROL TRANSFORMERS

GROUP II

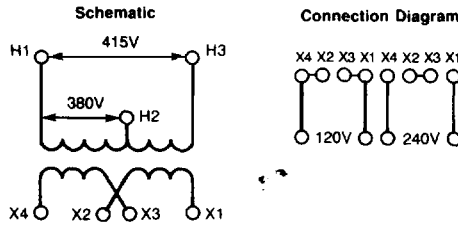

Primary Voltage: 380, 415. Secondary Voltage: 110/220. 50/60 Hz. CSA and UL listed.

Mfr. No.	VA Rating	Output Amps	Overall Dimens. (In.)			Mtg. Slot (In.)	Price Each
			A	B	C		
MT25MDMX	25	.21/.10	3.00	3.00	2.75	A	\$ 31.09
MT50MDMX	50	.42/.21	3.00	3.63	2.75	B	31.62
MT75MDMX	75	.63/.31	3.00	4.13	2.75	C	32.33
MT100MDMX	100	.83/.42	3.00	4.75	2.75	C	34.01
MT150MDMX	150	1.25/.63	4.50	4.25	3.75	B	43.02
MT200MDMX	200	1.67/.83	4.50	4.38	3.75	B	46.29
MT250MDMX	250	2.08/1.04	4.50	4.75	3.75	B	54.41
MT350MDMX	350	2.92/1.46	5.25	5.00	4.50	B	70.76
MT500MDMX	500	4.17/2.08	5.25	6.00	4.50	B	77.29
MT750MDMX	750	6.25/3.13	6.00	5.13	5.00	D	106.35
MT1000MDMX	1000	8.33/4.17	6.00	6.38	5.00	D	130.38

GROUP JJ

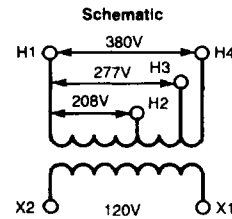

Primary Voltage: 208, 277, 380. Secondary Voltage: 120. 50/60 Hz. CSA and UL listed.

Mfr. No.	VA Rating	Output Amps	Overall Dimens. (In.)			Mtg. Slot (In.)	Price Each
			A	B	C		
MT25MGJ	25	0.21	3.00	3.13	2.63	A	\$ 31.54
MT50MGJ	50	0.42	3.00	3.63	2.63	B	33.57
MT75MGJ	75	0.63	3.00	4.13	2.63	C	35.69
MT100MGJ	100	0.83	3.00	4.75	2.63	C	37.90
MT150MGJ	150	1.25	4.50	4.25	3.13	B	49.20
MT200MGJ	200	1.67	4.50	4.38	3.75	B	61.75
MT250MGJ	250	2.08	4.50	4.75	3.75	B	66.87
MT350MGJ	350	2.92	5.25	5.13	4.50	B	82.77
MT500MGJ	500	4.17	5.25	6.00	4.50	B	91.78
MT750MGJ	750	6.25	6.00	5.25	5.00	D	129.50
MT1000MGJ	1000	8.33	6.00	6.38	5.00	D	151.85

SERIES MH MACHINE TOOL CONTROL TRANSFORMERS

GROUP A

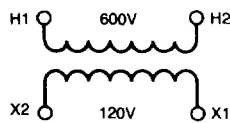

Primary Voltage: 600. Secondary Voltage: 120. 60 Hz. CSA and UL listed.

Mfr. No.	VA Rating	Output Amps	Overall Dimens. (In.)			Mtg. Slot* (In.)	Price Each
			A	B	C		
MH25AJ	25	0.21	3.00	3.00	2.75	A	\$ 20.60
MH50AJ	50	0.42	3.00	3.25	2.75	A	21.39
MH75AJ	75	0.63	3.00	3.75	2.75	A	26.15
MH100AJ	100	0.83	3.00	4.13	2.75	A	28.27
MH150AJ	150	1.25	3.75	3.88	3.25	B	34.15
MH200AJ	200	1.67	3.75	4.50	3.25	B	42.15
MH250AJ	250	2.08	4.50	4.38	3.85	B	50.56
MH350AJ	350	2.92	4.50	5.00	3.85	B	65.97
MH500AJ	500	4.17	6.00	4.00	5.10	C	72.04
MH750AJ	750	6.25	6.00	5.00	5.10	C	101.14
MH1000AJ	1000	8.33	6.00	5.63	5.10	C	121.74
MH1500AJ	1500	12.50	7.50	6.75	6.25	D	185.71
MH2000AJ	2000	16.67	7.50	7.25	6.25	D	259.19
MH3000AJ	3000	25.00	7.50	8.75	6.25	D	316.16

GROUP C

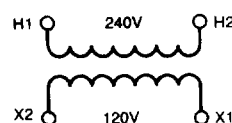

Primary Voltage: 240. Secondary Voltage: 120. 60 Hz. CSA and UL listed.

Mfr. No.	VA Rating	Output Amps	Overall Dimens. (In.)			Mtg. Slot* (In.)	Price Each
			A	B	C		
MH25MJ	25	0.21	3.00	3.00	2.75	A	\$18.66
MH50MJ	50	0.42	3.00	3.25	2.75	A	20.05
MH75MJ	75	0.63	3.00	3.75	2.75	A	23.50
MH100MJ	100	0.83	3.00	4.13	2.75	A	26.66
MH150MJ	150	1.25	3.75	3.88	3.25	B	31.92
MH200MJ	200	1.67	3.75	4.50	3.25	B	38.00
MH250MJ	250	2.08	4.50	4.38	3.85	B	45.81
MH350MJ	350	2.92	4.50	5.00	3.85	B	55.12
MH500MJ	500	4.17	6.00	4.00	5.10	C	66.59
MH750MJ	750	6.25	6.00	5.00	5.10	C	94.46

GROUP B

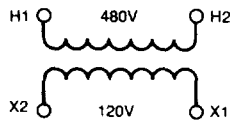

Primary Voltage: 480. Secondary Voltage: 120. 60 Hz. CSA and UL listed.

Mfr. No.	VA Rating	Output Amps	Overall Dimens. (In.)			Mtg. Slot* (In.)	Price Each
			A	B	C		
MH25CJ	25	0.21	3.00	3.00	2.75	A	\$ 18.66
MH50CJ	50	0.42	3.00	3.25	2.75	A	20.05
MH75CJ	75	0.63	3.00	3.75	2.75	A	23.50
MH100CJ	100	0.83	3.00	4.13	2.75	A	26.66
MH150CJ	150	1.25	3.75	3.88	3.25	B	31.92
MH200CJ	200	1.67	3.75	4.50	3.25	B	38.00
MH250CJ	250	2.08	4.50	4.38	3.85	B	45.81
MH350CJ	350	2.92	4.50	5.00	3.85	B	55.12
MH500CJ	500	4.17	6.00	4.00	5.10	C	66.59
MH750CJ	750	6.25	6.00	5.00	5.10	C	94.46
MH1000CJ	1000	8.33	6.00	5.63	5.10	C	115.20
MH1500CJ	1500	12.50	7.50	6.75	6.25	D	177.66

GROUP D

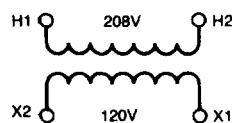

Primary Voltage: 208. Secondary Voltage: 120. 60 Hz. CSA and UL listed.

Mfr. No.	VA Rating	Output Amps	Overall Dimens. (In.)			Mtg. Slot* (In.)	Price Each
			A	B	C		
MH25LJ	25	0.21	3.00	3.00	2.75	A	\$28.48
MH50LJ	50	0.42	3.00	3.25	2.75	A	29.20
MH75LJ	75	0.63	3.00	3.75	2.75	A	31.84
MH100LJ	100	0.83	3.00	4.13	2.75	A	33.04
MH150LJ	150	1.25	3.75	3.88	3.25	B	43.00
MH200LJ	200	1.67	3.75	4.50	3.25	B	49.55
MH250LJ	250	2.08	4.50	4.38	3.85	B	58.69
MH350LJ	350	2.92	4.50	5.00	3.85	B	72.38
MH500LJ	500	4.17	6.00	4.00	5.10	C	79.87

* Mtg. Slots: A = .22 x .44; B = .22 x .56; C = .31 x .62; D = .38 x 1.00.



SERIES MH MACHINE TOOL CONTROL TRANSFORMERS

GROUP E

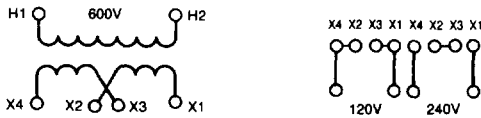

Primary Voltage: 600. Secondary Voltage: 120/240. 60 Hz. CSA and UL listed.

Mr. No.	VA Rating	Output Amps	Overall Dimens. (In.)			Mtg. Slot* (In.)	Price Each
			A	B	C		
MH25AP	25	.21/.10	3.00	3.00	2.75	A	\$ 31.87
MH50AP	50	.42/.21	3.00	3.25	2.75	A	32.44
MH75AP	75	.63/.31	3.00	3.75	2.75	A	33.35
MH100AP	100	.83/.42	3.00	4.13	2.75	A	33.83
MH150AP	150	1.25/.63	3.75	3.88	3.25	B	39.41
MH200AP	200	1.67/.83	3.75	4.50	3.25	B	44.93
MH250AP	250	2.08/1.04	4.50	4.38	3.85	B	48.16
MH350AP	350	2.92/1.46	4.50	5.00	3.85	B	54.41
MH500AP	500	4.17/2.08	6.00	4.00	5.10	C	81.21
MH750AP	750	6.25/3.13	6.00	5.00	5.10	C	127.52
MH1000AP	1000	8.33/4.17	6.00	5.63	5.10	C	134.78
MH1500AP	1500	12.5/6.25	7.50	6.75	6.25	D	190.18
MH2000AP	2000	16.6/8.33	7.50	7.25	6.25	D	264.77
MH3000AP	3000	25.0/12.5	7.50	8.75	6.25	D	332.63
MH5000AP	5000	41.7/20.8	9.00	10.25	7.50	E	484.01
MH7500AP	7500	62.5/31.3	9.00	12.00	7.50	E	569.28

GROUP F

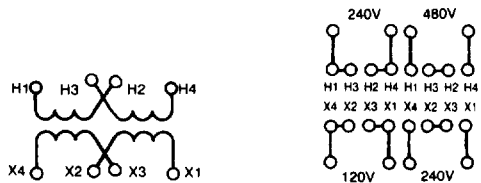

Primary Voltage: 240/480. Secondary Voltage: 120/240. 60 Hz. CSA and UL listed.

Mr. No.	VA Rating	Output Amps	Overall Dimens. (In.)			Mtg. Slot* (In.)	Price Each
			A	B	C		
MH25QP	25	.21/.10	3.00	3.00	2.75	A	\$ 32.88
MH50QP	50	.42/.21	3.00	3.25	2.75	A	33.43
MH75QP	75	.63/.31	3.00	3.88	2.75	A	34.38
MH100QP	100	.83/.42	3.00	4.25	2.75	A	34.89
MH150QP	150	1.25/.63	3.75	4.00	3.25	B	40.65
MH200QP	200	1.67/.83	3.75	4.50	3.25	B	46.30
MH250QP	250	2.08/1.04	4.50	4.38	3.85	B	49.66
MH350QP	350	2.92/1.46	4.50	5.00	3.85	B	56.11
MH500QP	500	4.17/2.08	6.00	4.00	5.10	C	83.72
MH750QP	750	6.25/3.13	6.00	5.00	5.10	C	131.46
MH1000QP	1000	8.33/4.17	6.00	5.63	5.10	C	138.95
MH1500QP	1500	12.5/6.25	7.50	6.75	6.25	D	196.08
MH2000QP	2000	16.6/8.33	7.50	7.25	6.25	D	272.99
MH3000QP	3000	25.0/12.5	7.50	8.75	6.25	D	342.93
MH5000QP	5000	41.7/20.8	9.00	10.25	7.50	E	499.00
MH7500QP	7500	62.5/31.3	9.00	12.00	7.50	E	586.89

GROUP G

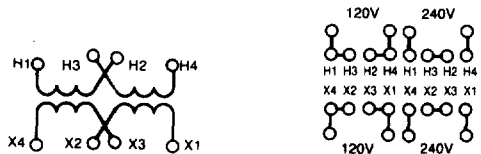

Primary Voltage: 120/240. Secondary Voltage: 120/240. 60 Hz. CSA and UL listed.

Mr. No.	VA Rating	Output Amps	Overall Dimens. (In.)			Mtg. Slot* (In.)	Price Each
			A	B	C		
MH25PP	25	.21/.10	3.00	3.00	2.75	A	\$ 26.36
MH50PP	50	.42/.21	3.00	3.25	2.75	A	33.88
MH75PP	75	.63/.31	3.00	3.88	2.75	A	35.65
MH100PP	100	.83/.42	3.00	4.25	2.75	A	36.48
MH150PP	150	1.25/.63	3.75	4.00	3.25	B	37.51
MH200PP	200	1.67/.83	3.75	4.50	3.25	B	42.72
MH250PP	250	2.08/1.04	4.50	4.38	3.85	B	48.17
MH350PP	350	2.92/1.46	4.50	5.00	3.85	B	62.82
MH500PP	500	4.17/2.08	6.00	4.00	5.10	C	85.24
MH750PP	750	6.25/3.13	6.00	5.00	5.10	C	173.19
MH1000PP	1000	8.33/4.17	6.00	5.63	5.10	C	180.39
MH1500PP	1500	12.5/6.25	7.50	6.75	6.25	F	257.42
MH2000PP	2000	16.6/8.33	7.50	7.25	6.25	F	263.11

GROUP H

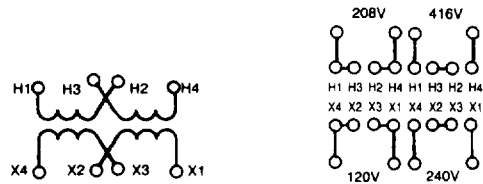

Primary Voltage: 208/416. Secondary Voltage: 120/240. 60 Hz. CSA and UL listed.

Mr. No.	VA Rating	Output Amps	Overall Dimens. (In.)			Mtg. Slot* (In.)	Price Each
			A	B	C		
MH25SP	25	.21/.10	3.00	3.00	2.75	A	\$ 41.46
MH50SP	50	.42/.21	3.00	3.25	2.75	A	42.15
MH75SP	75	.63/.31	3.00	3.84	2.75	A	42.35
MH100SP	100	.83/.42	3.00	4.25	2.75	A	42.56
MH150SP	150	1.25/.63	3.75	4.00	3.25	B	43.58
MH200SP	200	1.67/.83	3.75	4.50	3.25	B	44.36
MH250SP	250	2.08/1.04	4.50	4.38	3.85	B	59.82
MH350SP	350	2.92/1.46	4.50	5.00	3.85	B	67.01
MH500SP	500	4.17/2.08	6.00	4.00	5.10	C	89.53
MH750SP	750	6.25/3.13	6.00	5.00	5.10	C	129.09
MH1000SP	1000	8.33/4.17	6.00	5.63	5.10	C	132.82
MH1500SP	1500	12.5/6.25	7.50	6.75	6.25	D	225.71
MH2000SP	2000	16.6/8.33	7.50	7.25	6.25	D	243.06
MH3000SP	3000	25.0/12.5	7.50	8.75	6.25	D	332.31
MH5000SP	5000	41.7/20.8	9.00	10.25	7.50	E	507.17

GROUP I

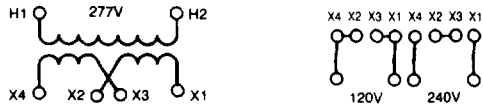

Primary Voltage: 277. Secondary Voltage: 120/240. 60 Hz. CSA and UL listed.

Mr. No.	VA Rating	Output Amps	Overall Dimens. (In.)			Mtg. Slot* (In.)	Price Each
			A	B	C		
MH25GP	25	.21/.10	3.00	3.00	2.75	A	\$ 32.70
MH50GP	50	.42/.21	3.00	3.25	2.75	A	33.96
MH75GP	75	.63/.31	3.00	3.75	2.75	A	35.14
MH100GP	100	.83/.42	3.00	4.13	2.75	A	36.23
MH150GP	150	1.25/.63	3.75	3.88	3.25	B	54.59
MH200GP	200	1.67/.83	3.75	4.50	3.25	B	105.17
MH250GP	250	2.08/1.04	4.50	4.38	3.85	B	111.49
MH350GP	350	2.92/1.46	4.50	5.00	3.85	B	129.73
MH500GP	500	4.17/2.08	6.00	4.00	5.10	C	129.87

GROUP J

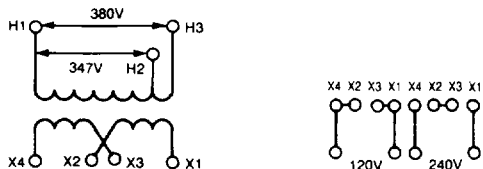

Primary Voltage: 347/380. Secondary Voltage: 120/240. 60 Hz. CSA and UL listed.

Mr. No.	VA Rating	Output Amps	Overall Dimens. (In.)			Mtg. Slot* (In.)	Price Each
			A	B	C		
MH25TP	25	.21/.10	3.00	3.00	2.75	A	\$ 43.64
MH50TP	50	.42/.21	3.00	3.25	2.75	A	44.38
MH75TP	75	.63/.31	3.00	3.88	2.75	A	44.64
MH100TP	100	.83/.42	3.00	4.25	2.75	A	44.82
MH150TP	150	1.25/.63	3.75	4.00	3.25	B	45.88
MH200TP	200	1.67/.83	3.75	4.63	3.25	B	46.71
MH250TP	250	2.08/1.04	4.50	4.50	3.85	B	62.96
MH350TP	350	2.92/1.46	4.50	5.00	3.85	B	70.54
MH500TP	500	4.17/2.08	6.00	4.00	5.10	C	94.23
MH750TP	750	6.25/3.13	6.00	5.00	5.10	C	135.87
MH1000TP	1000	8.33/4.17	6.00	5.63	5.10	C	146.58
MH1500TP	1500	12.5/6.25	7.50	6.75	6.25	D	237.58
MH2000TP	2000	16.6/8.33	7.50	7.25	6.25	D	255.86
MH3000TP	3000	25.0/12.5	7.50	8.75	6.25	D	349.80

* Mtg. Slots: A = .22 x .44; B = .22 x .56; C = .31 x .62; D = .38 x 1.00; E = .44 x 1.00; F = .38 x .63.



SERIES MH MACHINE TOOL CONTROL TRANSFORMERS

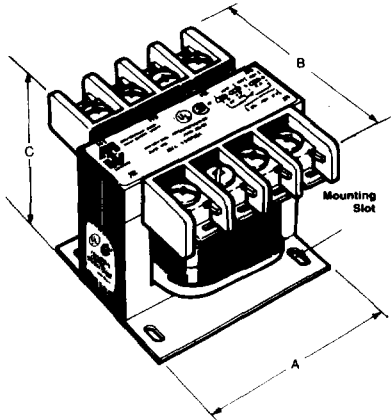

Up to 1000 VA

GROUP K

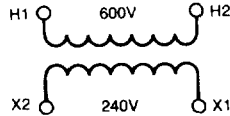

Primary Voltage: 600. Secondary Voltage: 240. 60 Hz. CSA and UL listed.

Mfr. No.	VA Rating	Output Amps	Overall Dimens. (In.)			Mtg. Slot* (In.)	Price Each
			A	B	C		
MH25AM	25	0.11	3.00	3.00	2.75	A	\$ 18.18
MH50AM	50	0.21	3.00	3.25	2.75	A	19.56
MH75AM	75	0.32	3.00	3.75	2.75	A	22.95
MH100AM	100	0.42	3.00	4.13	2.75	A	25.99
MH150AM	150	0.63	3.75	3.88	3.25	B	31.15
MH200AM	200	0.84	3.75	4.50	3.25	B	37.06
MH250AM	250	1.04	4.50	4.38	3.85	B	44.66
MH350AM	350	1.46	4.50	5.00	3.85	B	53.76
MH500AM	500	2.09	6.00	4.00	5.10	C	64.93
MH750AM	750	3.13	6.00	5.00	5.10	C	92.13
MH1000AM	1000	4.17	6.00	5.63	5.10	C	112.45
MH1500AM	1500	6.25	7.50	6.75	6.25	D	178.35

GROUP L

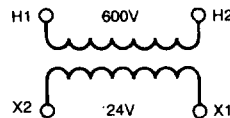

Primary Voltage: 600. Secondary Voltage: 240. 60 Hz. CSA and UL listed.

Mfr. No.	VA Rating	Output Amps	Overall Dimens. (In.)			Mtg. Slot* (In.)	Price Each
			A	B	C		
MH25AG	25	1.04	3.00	3.00	2.75	A	\$18.23
MH50AG	50	2.08	3.00	3.25	2.75	A	18.60
MH75AG	75	3.13	3.00	3.75	2.75	A	21.98
MH100AG	100	4.17	3.00	4.13	2.75	A	23.78
MH150AG	150	6.25	3.75	3.88	3.25	B	35.21
MH200AG	200	8.33	3.75	4.50	3.25	B	42.15
MH250AG	250	10.40	4.50	4.38	3.85	B	45.51

GROUP M

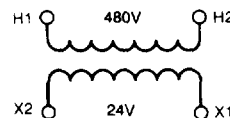

Primary Voltage: 480. Secondary Voltage: 24. 60 Hz. CSA and UL listed.

Mfr. No.	VA Rating	Output Amps	Overall Dimens. (In.)			Mtg. Slot* (In.)	Price Each
			A	B	C		
MH25CG	25	1.04	3.00	3.00	2.75	A	\$21.78
MH50CG	50	2.08	3.00	3.25	2.75	A	23.00
MH75CG	75	3.13	3.00	3.75	2.75	A	28.27
MH100CG	100	4.17	3.00	4.13	2.75	A	30.69
MH150CG	150	6.25	3.75	3.88	3.25	B	36.78
MH200CG	200	8.33	3.75	4.50	3.25	B	45.81
MH250CG	250	10.40	4.50	4.38	3.85	B	59.91

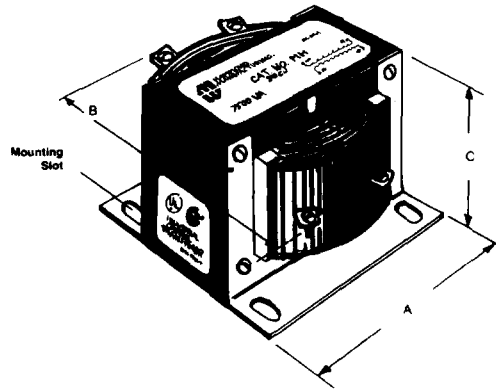

1500 to 7500 VA

GROUP N

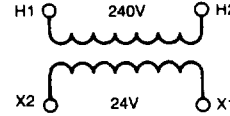

Primary Voltage: 240. Secondary Voltage: 24. 60 Hz. CSA and UL listed.

Mfr. No.	VA Rating	Output Amps	Overall Dimens. (In.)			Mtg. Slot* (In.)	Price Each
			A	B	C		
MH25MG	25	1.04	3.00	3.00	2.75	A	\$21.78
MH50MG	50	2.08	3.00	3.25	2.75	A	23.00
MH75MG	75	3.13	3.00	3.75	2.75	A	28.27
MH100MG	100	4.17	3.00	4.13	2.75	A	30.69
MH150MG	150	6.25	3.75	3.88	3.25	B	36.78
MH200MG	200	8.33	3.75	4.50	3.25	B	45.81
MH250MG	250	10.40	4.50	4.38	3.85	B	59.91

GROUP O

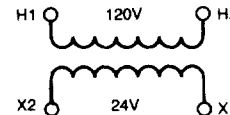

Primary Voltage: 120. Secondary Voltage: 24. 60 Hz. CSA and UL listed.

Mfr. No.	VA Rating	Output Amps	Overall Dimens. (In.)			Mtg. Slot* (In.)	Price Each
			A	B	C		
MH25JG	25	1.04	3.00	3.00	2.75	A	\$21.78
MH50JG	50	2.08	3.00	3.25	2.75	A	23.00
MH75JG	75	3.13	3.00	3.75	2.75	A	28.27
MH100JG	100	4.17	3.00	4.13	2.75	A	30.69
MH150JG	150	6.25	3.75	3.88	3.25	B	36.78
MH200JG	200	8.33	3.75	4.50	3.25	B	45.81
MH250JG	250	10.40	4.50	4.38	3.85	B	59.91

GROUP P

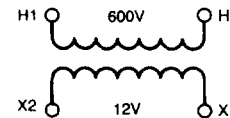

Primary Voltage: 600. Secondary Voltage: 12. 60 Hz. CSA and UL listed.

Mfr. No.	VA Rating	Output Amps	Overall Dimens. (In.)			Mtg. Slot* (In.)	Price Each
			A	B	C		
MH25AE	25	2.08	3.00	3.00	2.75	A	\$18.23
MH50AE	50	4.17	3.00	3.25	2.75	A	18.60
MH75AE	75	6.25	3.00	3.75	2.75	A	21.98
MH100AE	100	8.33	3.00	4.13	2.75	A	23.78
MH150AE	150	12.50	3.75	3.88	3.25	B	35.21
MH200AE	200	16.70	3.75	4.50	3.25	B	42.15
MH250AE	250	20.80	4.50	5.00	3.85	B	45.51

*Mtg. slots: A = .22 x .44; B = .22 x .56; C = .31 x .62; D = .38 x 1.00.



SERIES MH MACHINE TOOL CONTROL TRANSFORMERS

GROUP Q

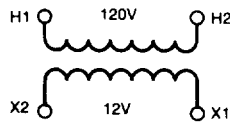

Primary Voltage: 120. Secondary Voltage: 12. 60 Hz. CSA and UL listed.

Mfr. No.	VA Rating	Output Amps	Overall Dimens. (in.)			Mtg. Slot* (in.)	Price Each
			A	B	C		
MH25JE	25	2.08	3.00	3.00	2.75	A	\$19.89
MH50JE	50	4.17	3.00	3.25	2.75	A	21.27
MH75JE	75	6.25	3.00	3.75	2.75	A	23.85
MH100JE	100	8.33	3.00	4.13	2.75	A	26.98
MH150JE	150	12.50	3.75	3.88	3.25	B	42.51
MH200JE	200	16.70	3.75	4.50	3.25	B	44.13
MH250JE	250	20.80	4.50	5.00	3.85	B	64.82

GROUP R

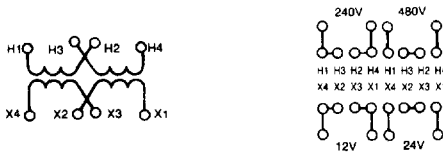

Primary Voltage: 240/480. Secondary Voltage: 12/24. 60 Hz. CSA and UL listed.

Mfr. No.	VA Rating	Output Amps	Overall Dimens. (in.)			Mtg. Slot* (in.)	Price Each
			A	B	C		
MH25QR	25	2.08/1.04	3.00	3.00	2.75	A	\$ 30.62
MH50QR	50	4.17/2.08	3.00	3.25	2.75	A	39.66
MH75QR	75	6.25/3.13	3.00	3.88	2.75	A	39.84
MH100QR	100	8.33/4.17	3.00	4.25	2.75	A	39.93
MH150QR	150	12.5/6.25	3.75	4.00	3.25	B	41.59
MH200QR	200	16.7/8.33	3.75	4.63	3.25	B	53.37
MH250QR	250	20.8/10.4	4.50	5.13	3.85	B	65.97
MH350QR	350	29.2/14.6	4.50	5.50	3.85	B	70.65
MH500QR	500	41.7/20.9	6.00	5.63	5.10	C	90.58
MH750QR	750	62.5/31.3	6.00	6.50	5.10	C	160.70
MH1000QR	1000	83.3/41.7	6.00	7.50	5.10	C	250.02
MH1500QR	1500	125/62.5	7.50	7.00	6.25	D	262.77

GROUP S

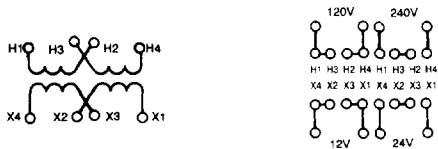

Primary Voltage: 120/240. Secondary Voltage: 12/24. 60 Hz. CSA and UL listed.

Mfr. No.	VA Rating	Output Amps	Overall Dimens. (in.)			Mtg. Slot* (in.)	Price Each
			A	B	C		
MH25PR	25	2.08/1.04	3.00	3.00	2.75	A	\$ 30.51
MH50PR	50	4.17/2.08	3.00	3.25	2.75	A	39.56
MH75PR	75	6.25/3.13	3.00	3.88	2.75	A	40.47
MH100PR	100	8.33/4.17	3.00	4.25	2.75	A	40.88
MH150PR	150	12.5/6.25	3.75	4.00	3.25	B	41.64
MH200PR	200	16.7/8.33	3.75	4.63	3.25	B	53.57
MH250PR	250	20.8/10.4	4.50	5.13	3.85	B	63.12
MH350PR	350	29.2/14.6	4.50	5.50	3.85	B	73.48
MH500PR	500	41.7/20.9	6.00	5.63	5.10	C	129.09
MH750PR	750	62.5/31.3	6.00	6.50	5.10	C	183.96
MH1000PR	1000	83.3/41.7	6.00	7.50	5.10	C	224.53
MH1500PR	1500	125/62.5	7.50	7.00	6.25	E	232.40
MH2000PR	2000	166/83.4	7.50	7.25	6.25	E	270.04
MH3000PR	3000	250/125	7.50	8.75	6.25	E	454.99

GROUP T

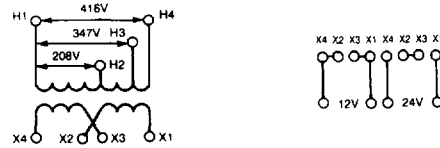

Primary Voltage: 208/347/416. Secondary Voltage: 12/24. 60 Hz. CSA and UL listed.

Mfr. No.	VA Rating	Output Amps	Overall Dimens. (in.)			Mtg. Slot* (in.)	Price Each
			A	B	C		
MH25WR	25	2.08/1.04	3.00	3.00	2.75	A	\$ 34.17
MH50WR	50	4.17/2.08	3.00	3.50	2.75	A	35.14
MH75WR	75	6.25/3.13	3.00	3.88	2.75	A	41.73
MH100WR	100	8.33/4.17	3.00	4.25	2.75	A	48.90
MH150WR	150	12.5/6.25	3.75	4.13	3.25	B	49.29
MH200WR	200	16.7/8.33	3.75	4.75	3.25	B	60.49
MH250WR	250	20.8/10.4	4.50	5.13	3.85	B	62.38
MH350WR	350	29.2/14.6	4.50	5.50	3.83	B	93.26
MH500WR	500	41.7/20.9	6.00	5.88	5.10	C	146.39
MH750WR	750	62.5/31.3	6.00	6.63	5.10	C	186.45
MH1000WR	1000	83.3/41.7	6.00	7.63	5.10	C	249.74
MH1500WR	1500	125/62.5	7.50	7.00	6.25	E	444.53
MH2000WR	2000	166/83.4	7.50	7.25	6.25	E	528.47
MH3000WR	3000	250/125	7.50	8.75	6.25	E	543.71

*Mtg. Slots: A = .22 x .44; B = .22 x .56; C = .31 x .62; D = .38 x .63; E = .38 x 1.00.

Eleven new models of the MH Series of control transformers make several popular voltages available in economical single primary and secondary voltage complications. The new models offer the same outstanding features and high quality of the MH Series. They are fully CSA certified and UL listed.

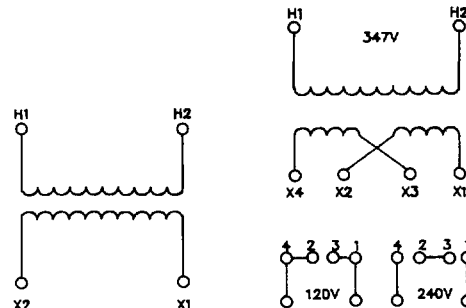

Primary Voltage: 208. Secondary Voltage: 24.

Mfr. Number	VA Rating	Dimens. (in.)			Mtg. Slot (in.)	Price Each
		A	B	C		
MH50LG	50	3.00	3.25	2.75	.22 x .44	\$23.00
MH100LG	100	3.00	4.13	2.75	.22 x .44	30.67

Primary Voltage: 347. Secondary Voltage: 24.

MH50KG	50	3.00	3.25	2.75	.22 x .44	\$23.00
MH100KG	100	3.00	4.13	2.75	.22 x .44	30.67

Primary Voltage: 120. Secondary Voltage: 120.

MH50JJ	50	3.00	3.25	2.75	.22 x .44	\$29.20
MH150JJ	150	3.75	3.88	3.25	.22 x .56	43.00
MH250JJ	250	4.50	4.38	3.85	.22 x .56	58.67

Primary Voltage: 480. Secondary Voltage: 240.

MH25CM	25	3.00	3.00	2.75	.22 x .44	\$18.20
--------	----	------	------	------	-----------	---------

Primary Voltage: 347. Secondary Voltage: 120/240.

MH50KP	50	3.00	3.25	2.75	.22 x .44	\$33.94
MH100KP	100	3.00	4.13	2.75	.22 x .44	36.23
MH150KP	150	3.75	4.00	3.25	.22 x .56	54.59



SERIES MH MACHINE TOOL CONTROL TRANSFORMERS

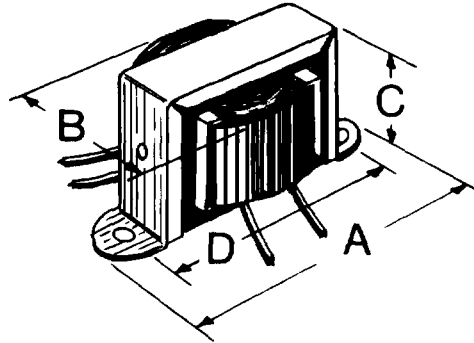

Chassis Mount

GROUP U—CHASSIS MOUNT WITH 10" LEADS

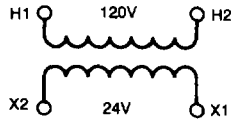

Primary Voltage: 120. Secondary Voltage: 24. 60 Hz. CSA and UL listed.

Mr. Number	VA Rating	Output Amps	Overall Dimensions (in.)			D (in.)	Price Each
			A	B	C		
MHC25JG	25	1.04	3.69	2.13	2.31	3.13	\$17.12
MHC50JG	50	2.08	4.00	2.50	2.63	3.56	19.01

GROUP V—CHASSIS MOUNT WITH 10" LEADS

Schematic

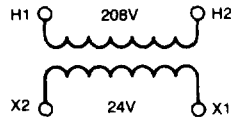

Primary Voltage: 208. Secondary Voltage: 24. 60 Hz. CSA and UL listed.

Mr. Number	VA Rating	Output Amps	Overall Dimensions (in.)			D (in.)	Price Each
			A	B	C		
MHC25LG	25	1.04	3.69	2.13	2.31	3.13	\$17.74
MHC50LG	50	2.08	4.00	2.50	2.63	3.56	19.42

VOLTAGE LINKS

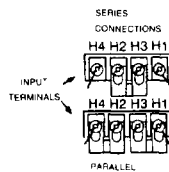

Voltage links are included at no extra charge for user installation to ensure links are installed on the correct voltage combination.

SECONDARY FUSE KIT

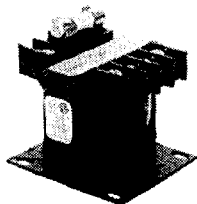

Optional secondary fuse kits are available to accommodate either 1/4" x 1/4" or 19/32" x 1 1/2" cartridge or cannister fuses. Fuses snap into place for easy installation in the terminal block. Kits meet UL and CSA requirements. Fuses are not included and the secondary voltage must be a single voltage and less than 250 volts.

Mfg. No.	Fuse Size	Price Each
MHFK1	1/4" x 1/4"	\$3.53
MHFK2	19/32" x 1 1/2"	3.53

GROUP W—CHASSIS MOUNT WITH 10" LEADS

Schematic

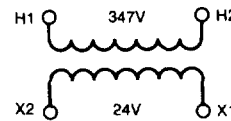

Primary Voltage: 347. Secondary Voltage: 24. 60 Hz. CSA and UL listed.

Mr. Number	VA Rating	Output Amps	Overall Dimensions (in.)			D (in.)	Price Each
			A	B	C		
MHC25KG	25	1.04	3.69	2.13	2.31	3.13	\$18.71
MHC50KG	50	2.08	4.00	2.50	2.63	3.56	20.30

GROUP X—CHASSIS MOUNT WITH 10" LEADS

Schematic

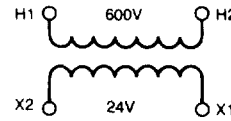

Primary Voltage: 600. Secondary Voltage: 24. 60 Hz. CSA and UL listed.

Mr. Number	VA Rating	Output Amps	Overall Dimensions (in.)			D (in.)	Price Each
			A	B	C		
MHC25AG	25	1.04	3.69	2.13	2.31	3.13	\$19.01
MHC50AG	50	2.08	4.00	2.50	2.63	3.56	20.83

PRIMARY FUSE KITS

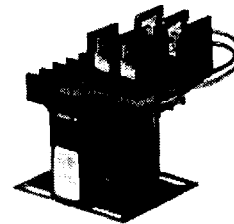

The optional primary fuse kits provide universal primary fusing on the complete line of Hammond machine tool transformers from 50VA to 1000VA. The PFK1 and PFK2 enable users to comply with the UL requirements that industrial control transformers have dual primary fusing protection. The pre-engineered kit includes a dual fuse block, lead wire harness and all necessary mounting hardware. Fuse kits are easily installed and save panel space. Also recommended for fusing transformers with dual secondary windings.

Mfr. No.	Fuse Size	Price Each
PFK1	Rejection type Class CC	\$12.19
PFK2	Non-rejection type Class CC	12.19